

FIG. 1

1

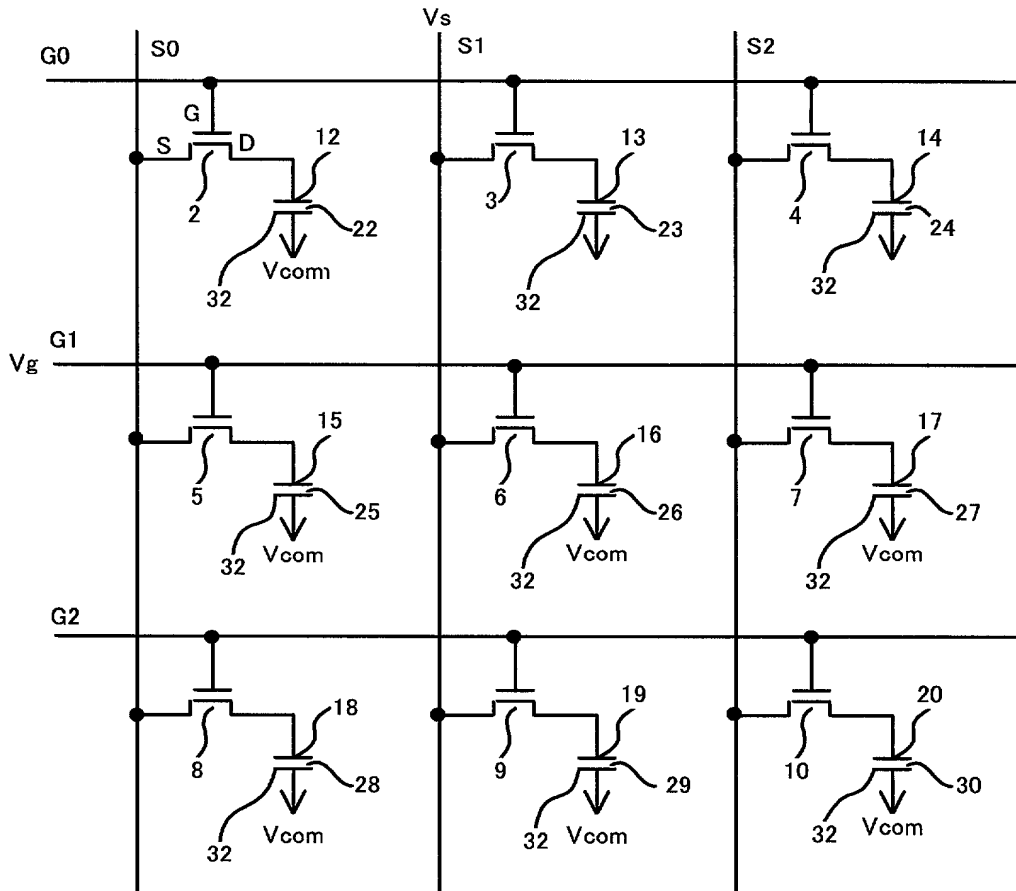

FIG. 2A

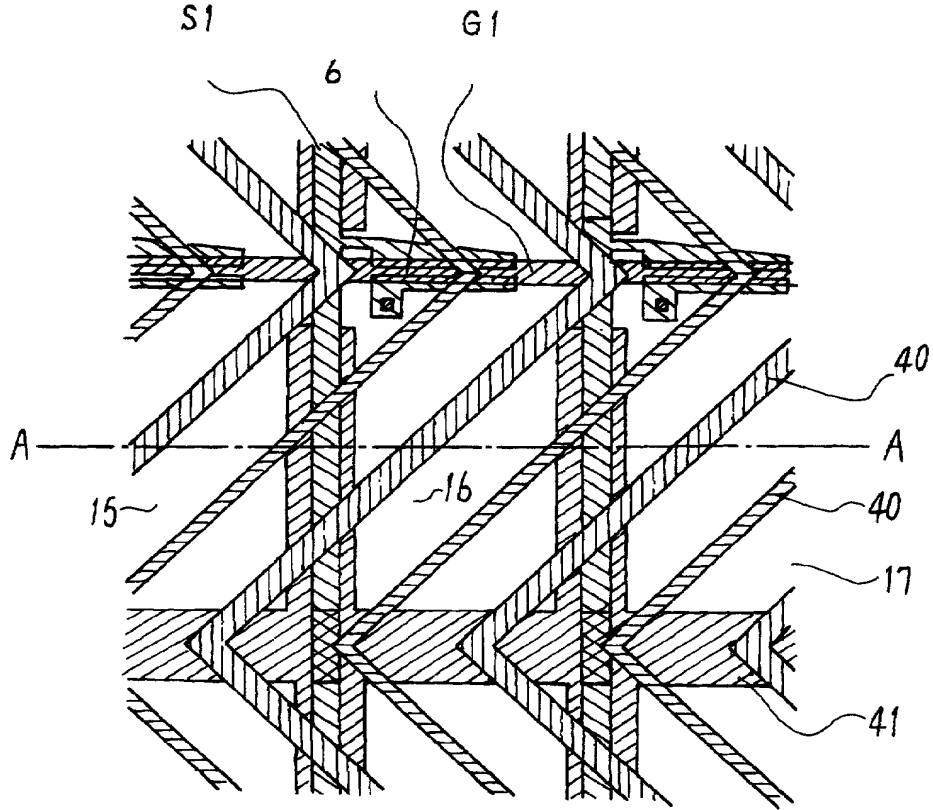

FIG. 2B

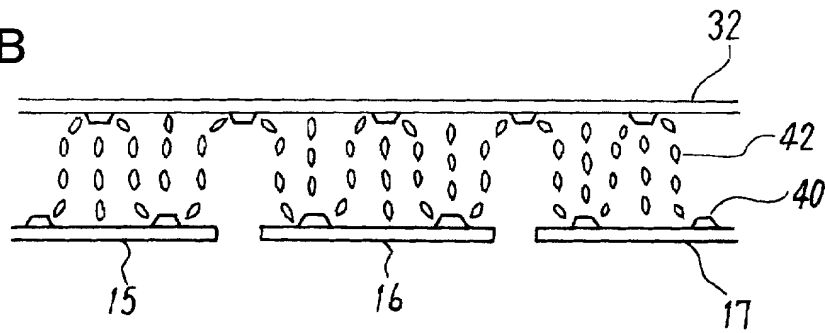

FIG. 3A

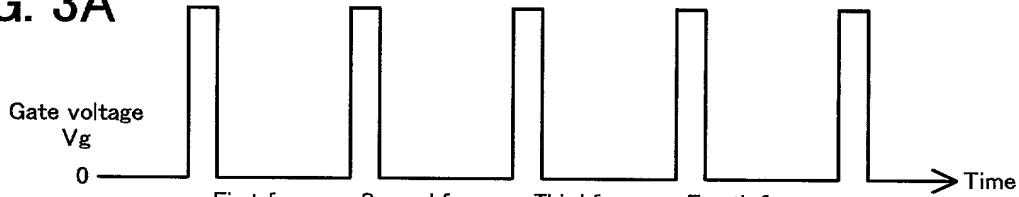

FIG. 3B

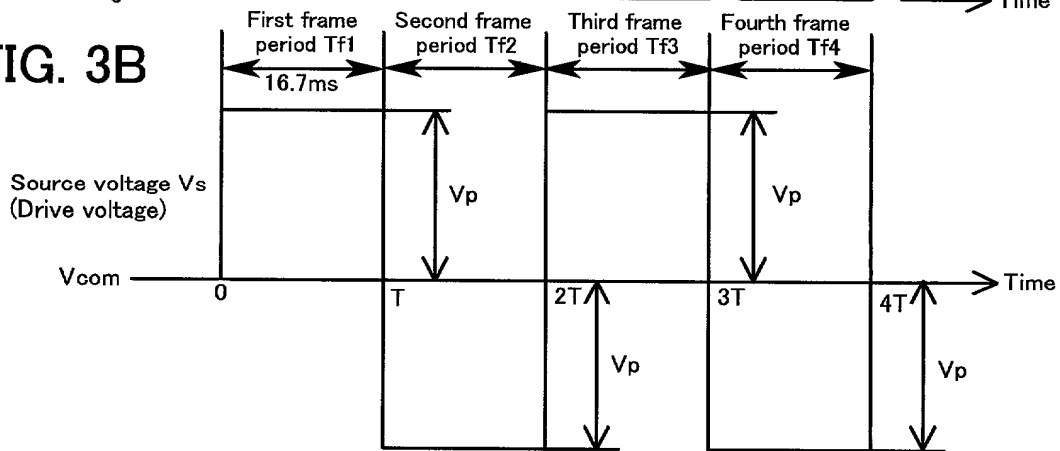

FIG. 3C

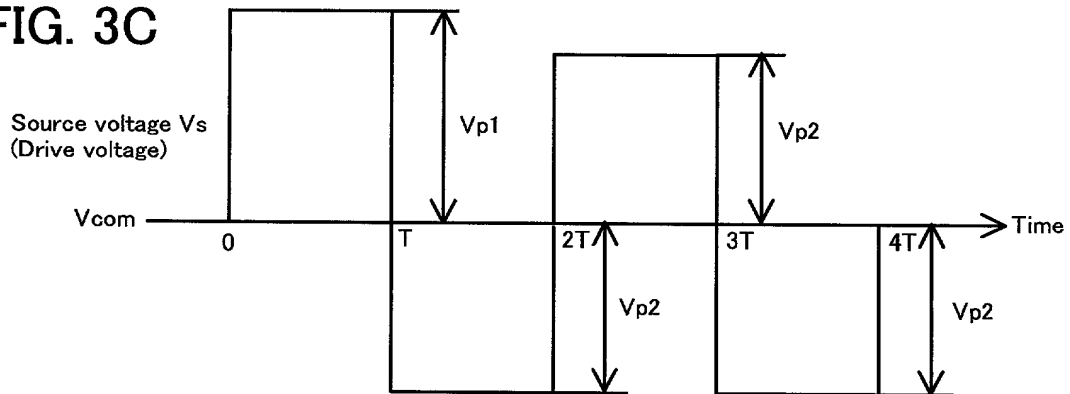

FIG. 4A

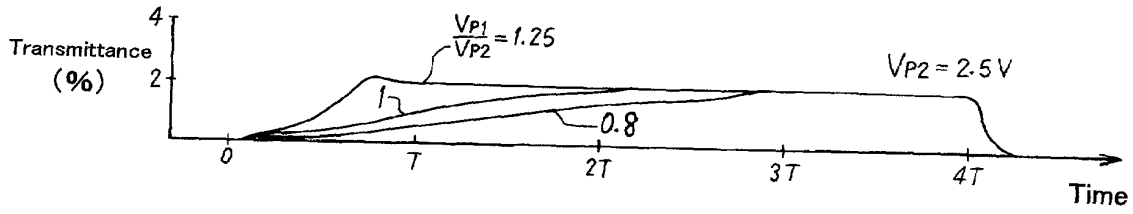

FIG. 4B

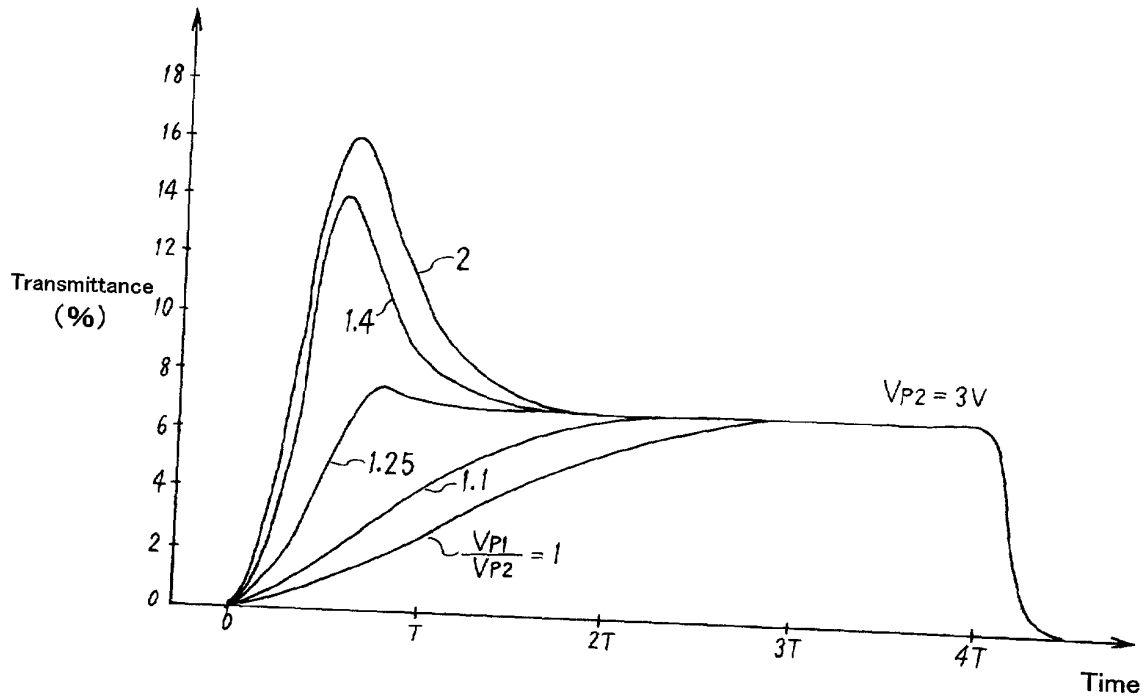

FIG. 5A

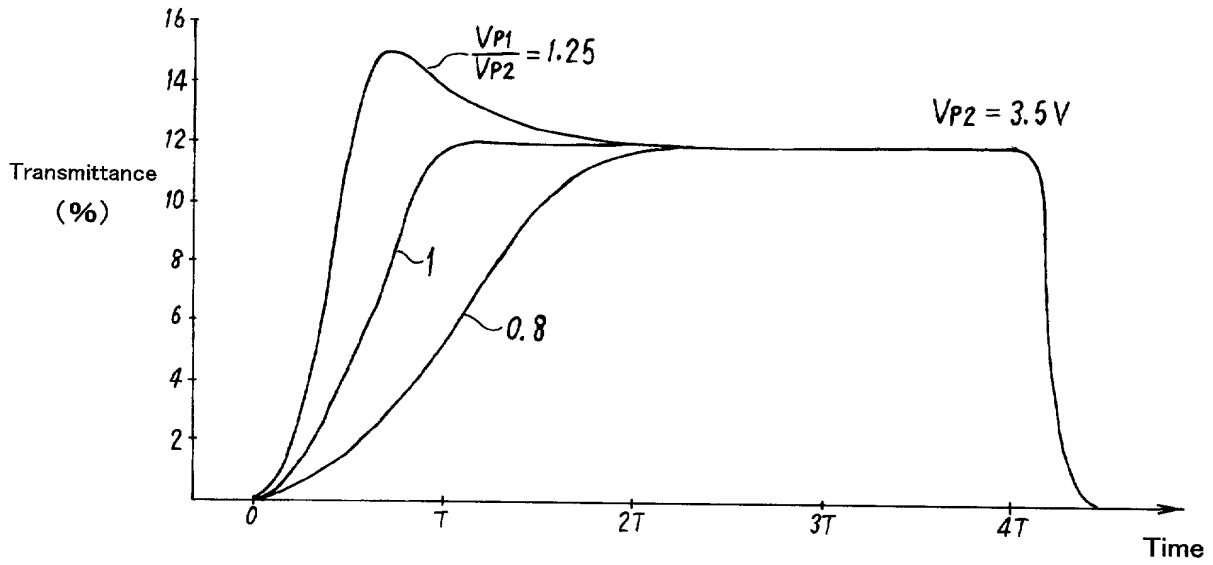

FIG. 5B

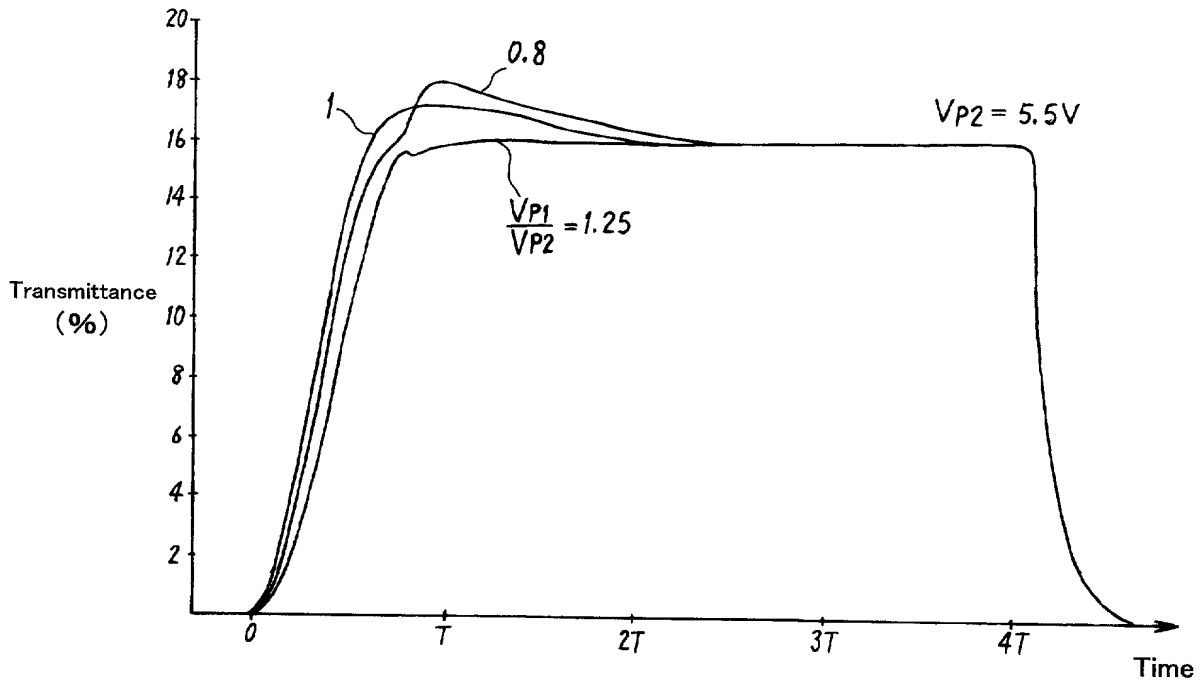

FIG. 6A

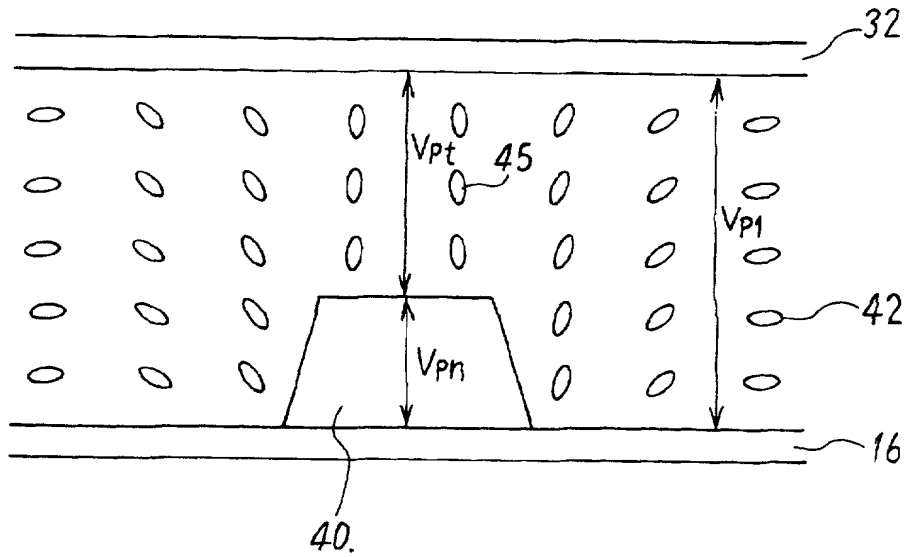

FIG. 6B

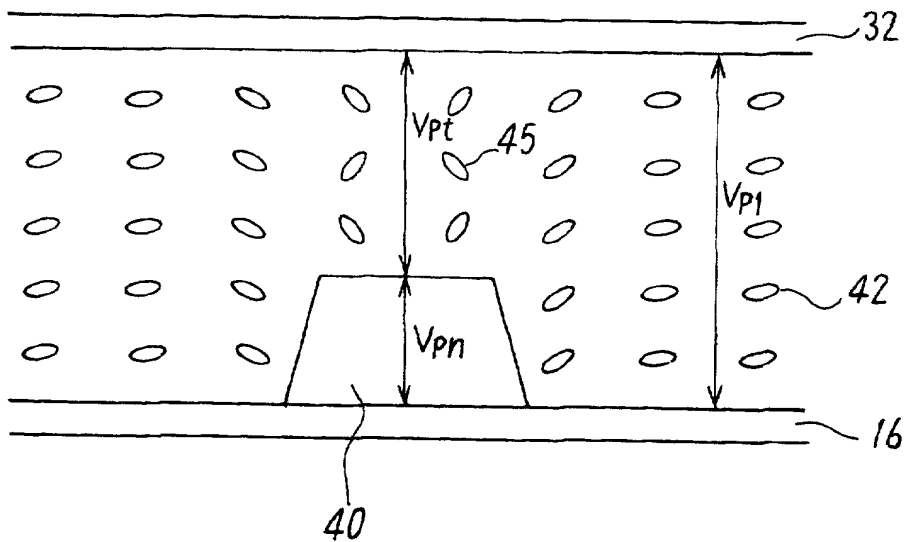

FIG. 7

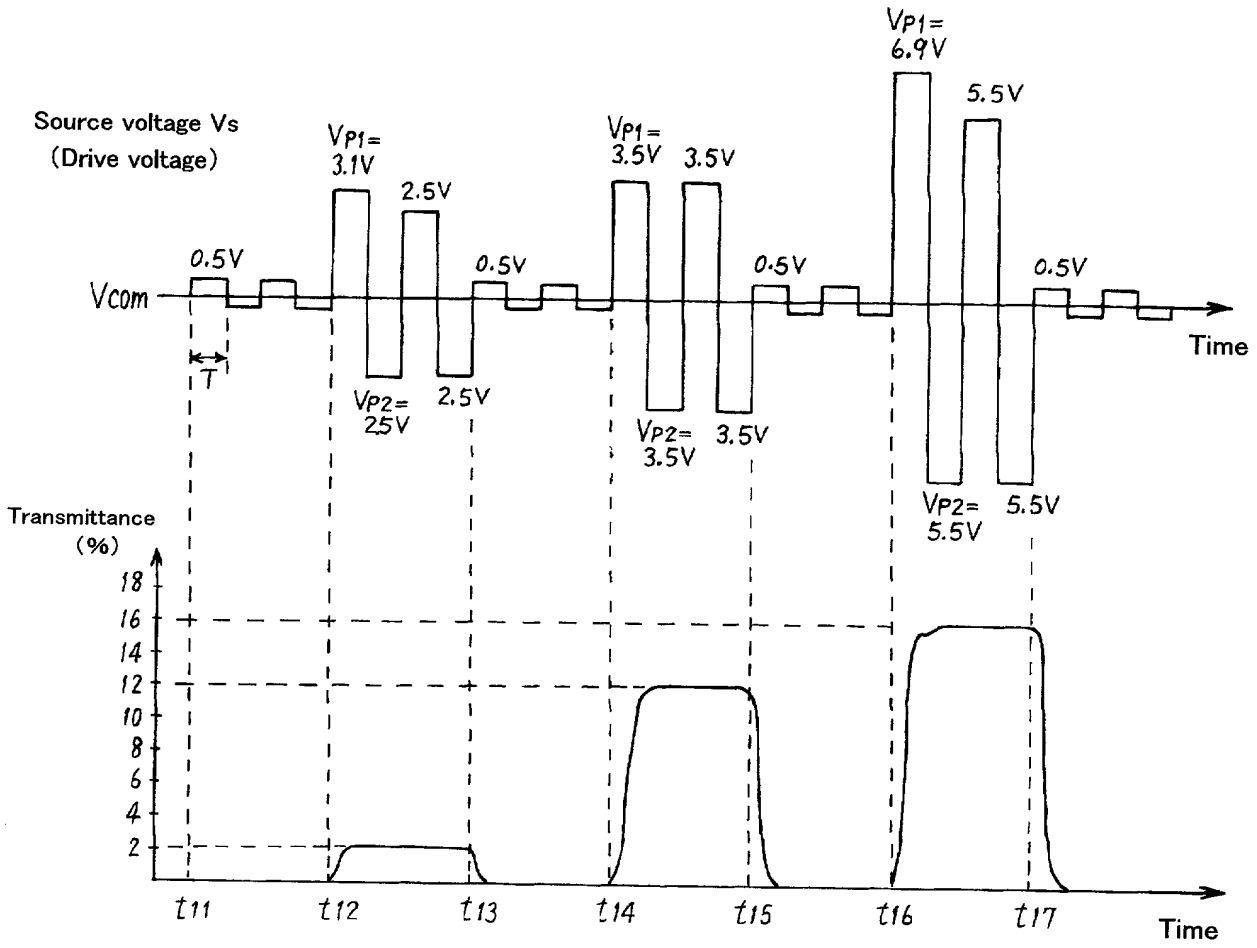

FIG. 8

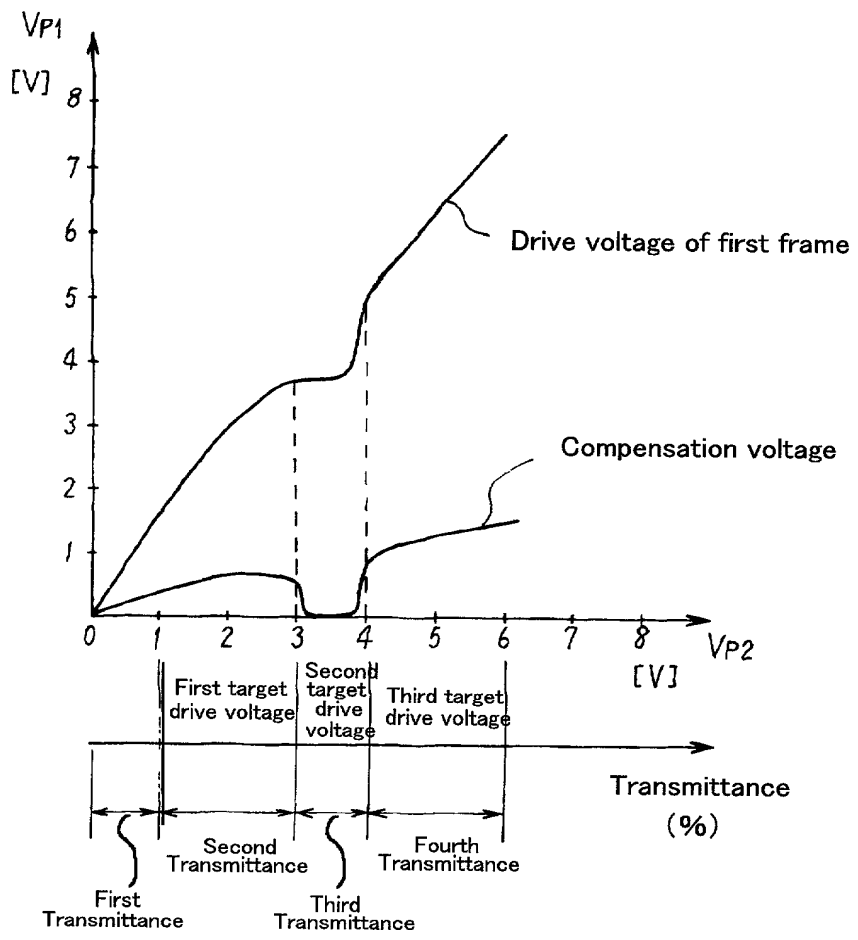

FIG. 9

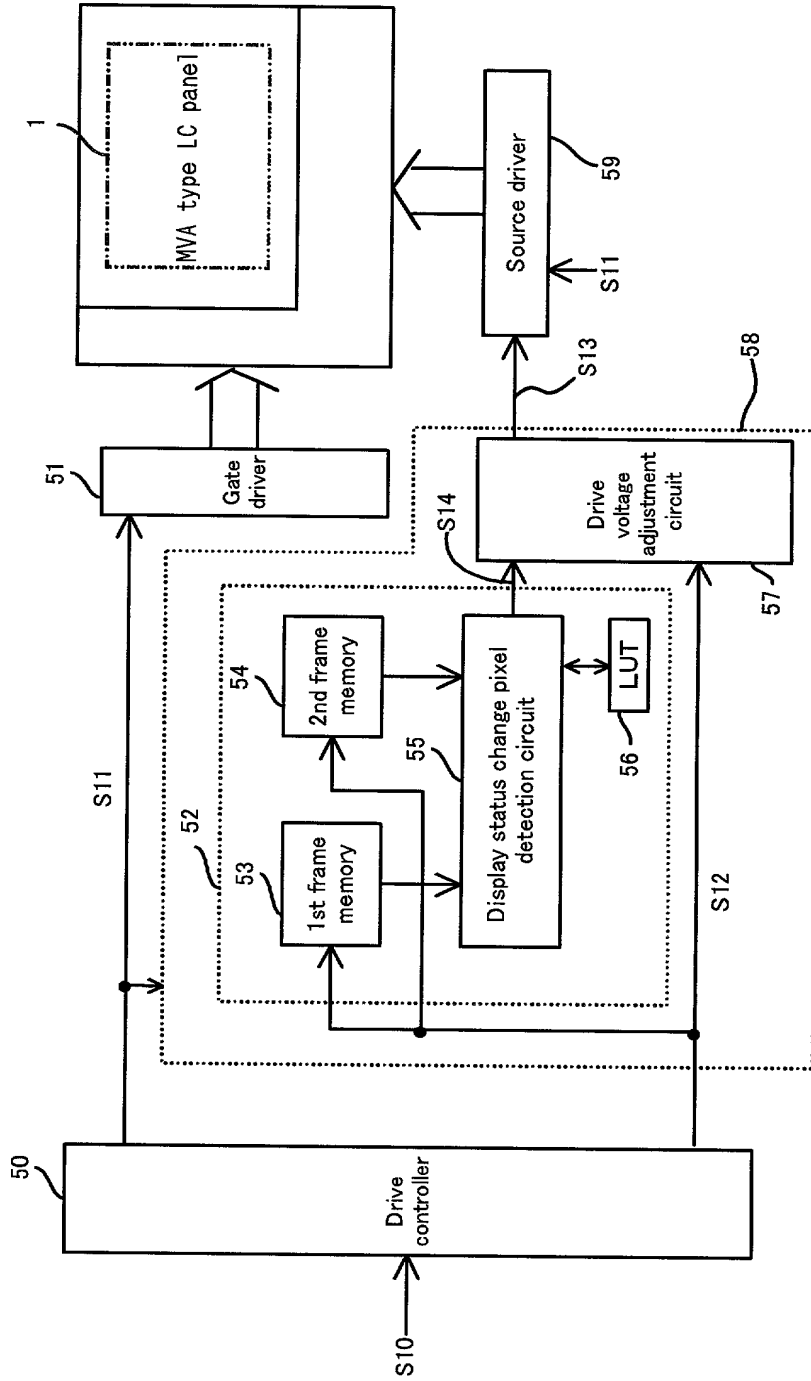
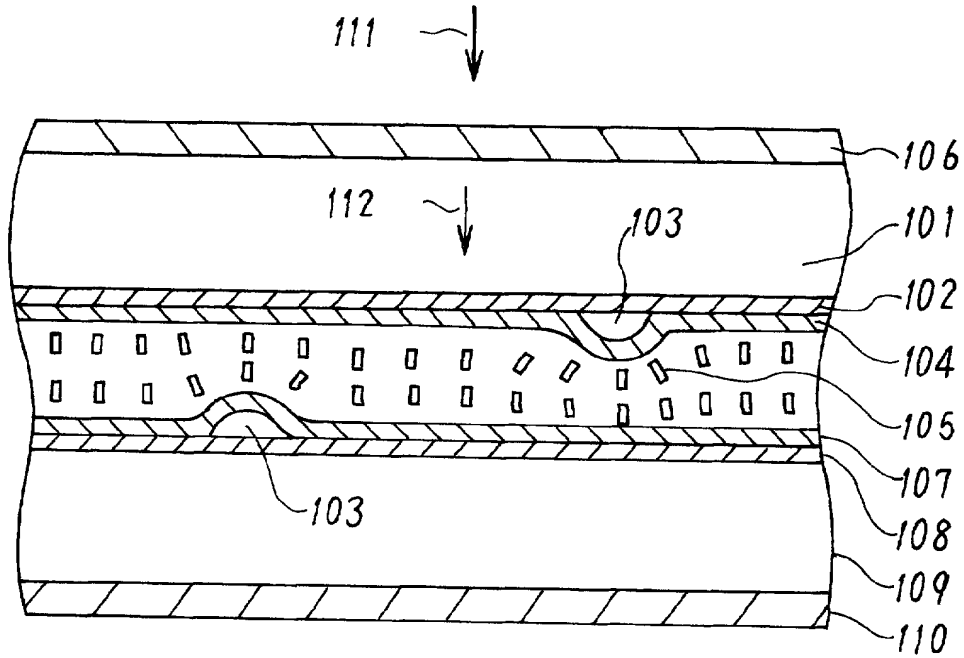

FIG. 10



111
112
106
101
102
104
105
107
108
109
110
103
103

FIG. 11A

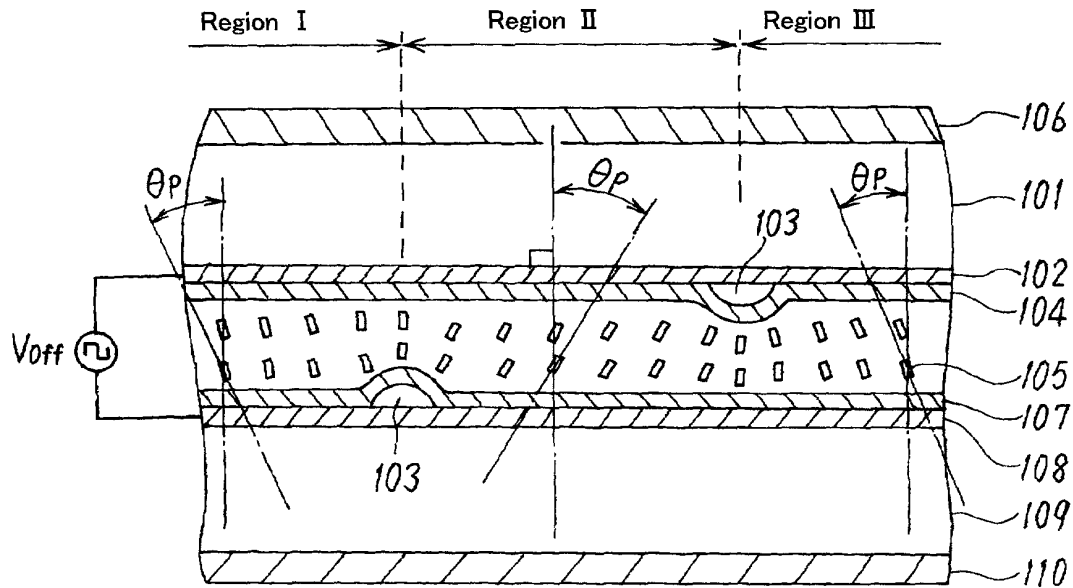

FIG. 11B

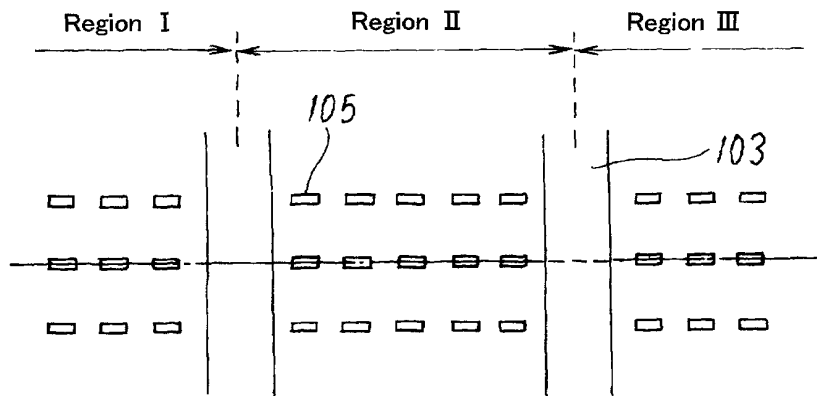

FIG. 12

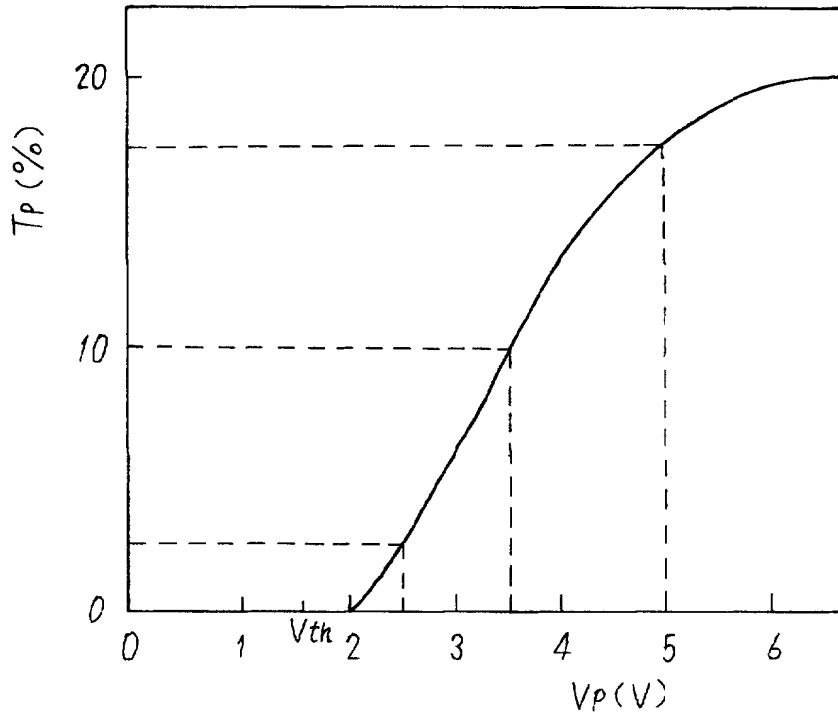

FIG. 13

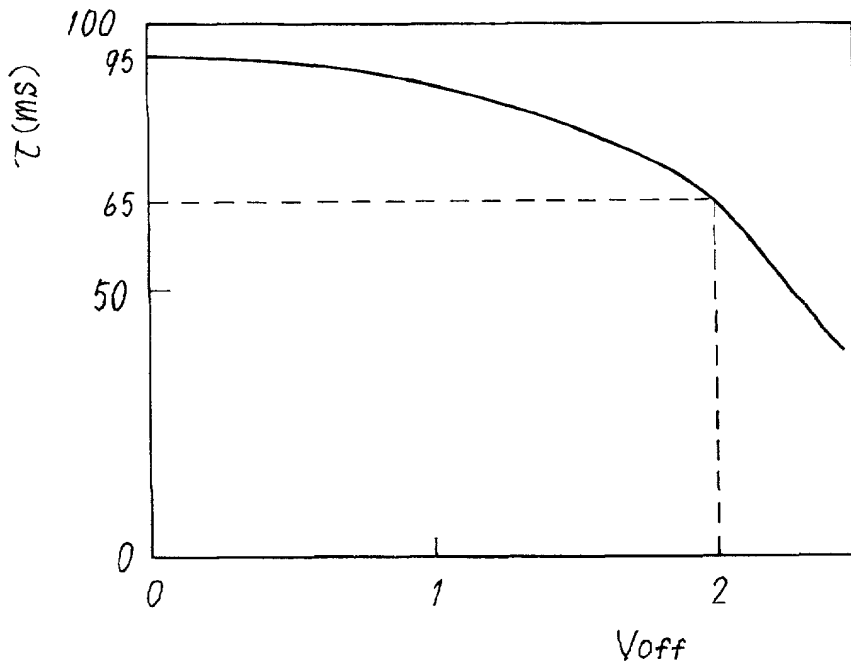

FIG. 14

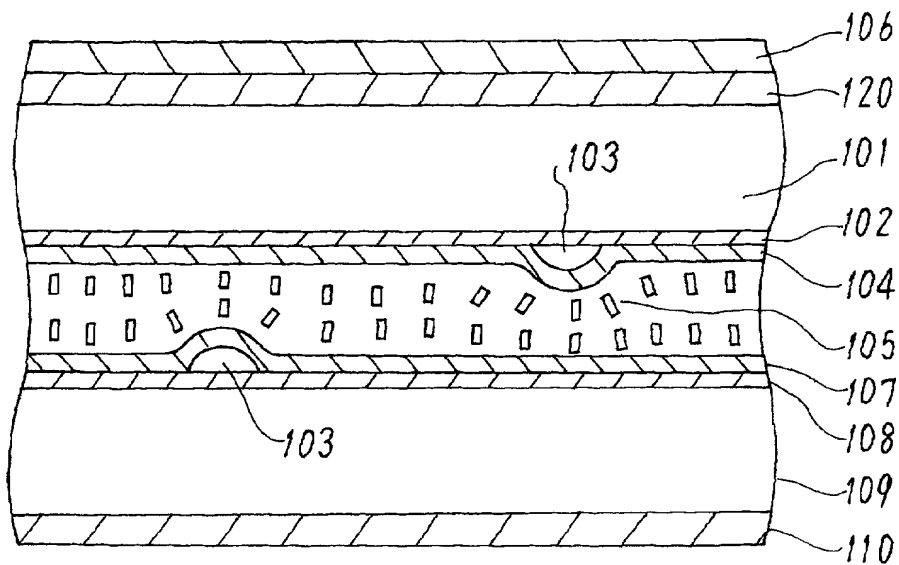

FIG. 15

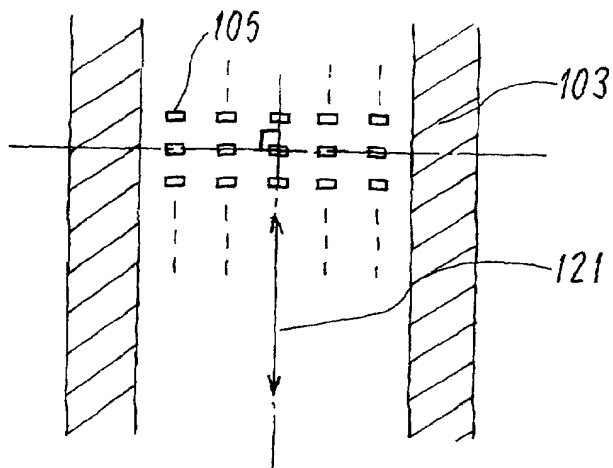

FIG. 16

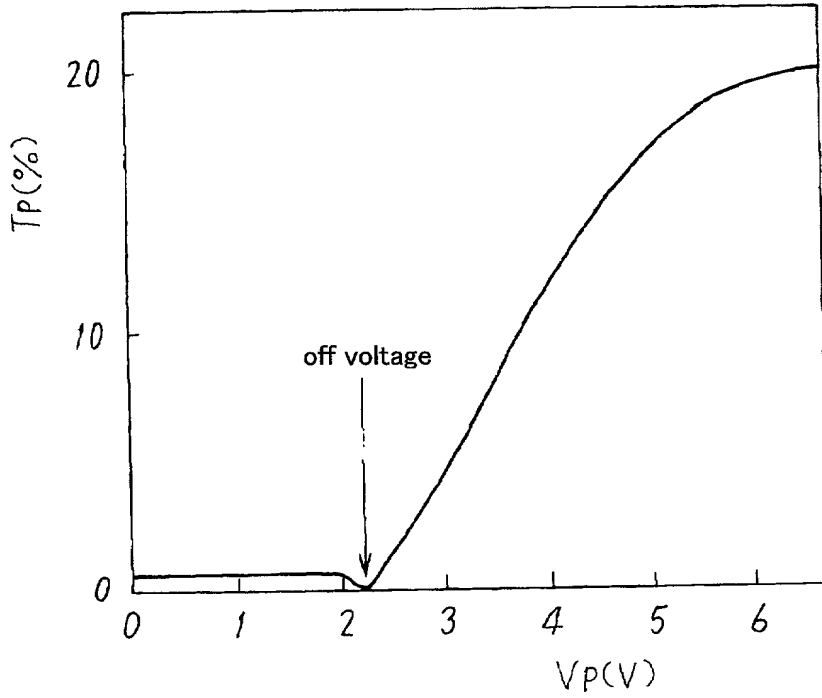

FIG. 17

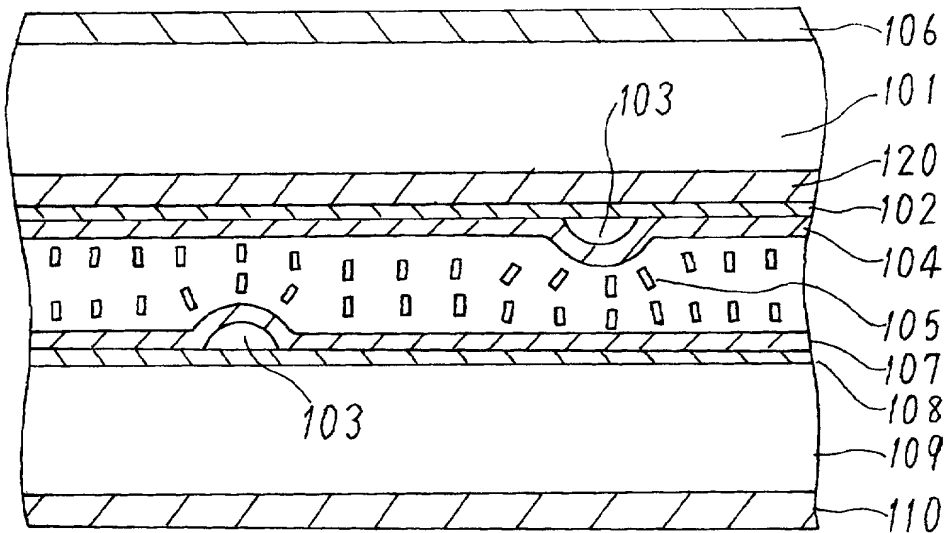
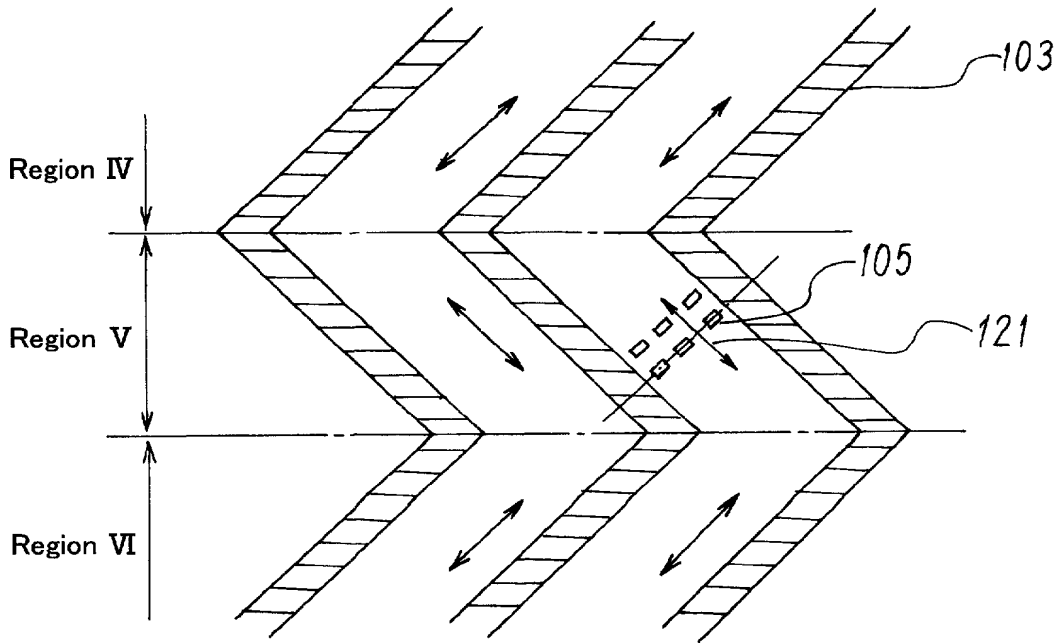

FIG. 18



Patented by Greer, Burns & Crain, Ltd. (Patrick Burns)

FIG. 19

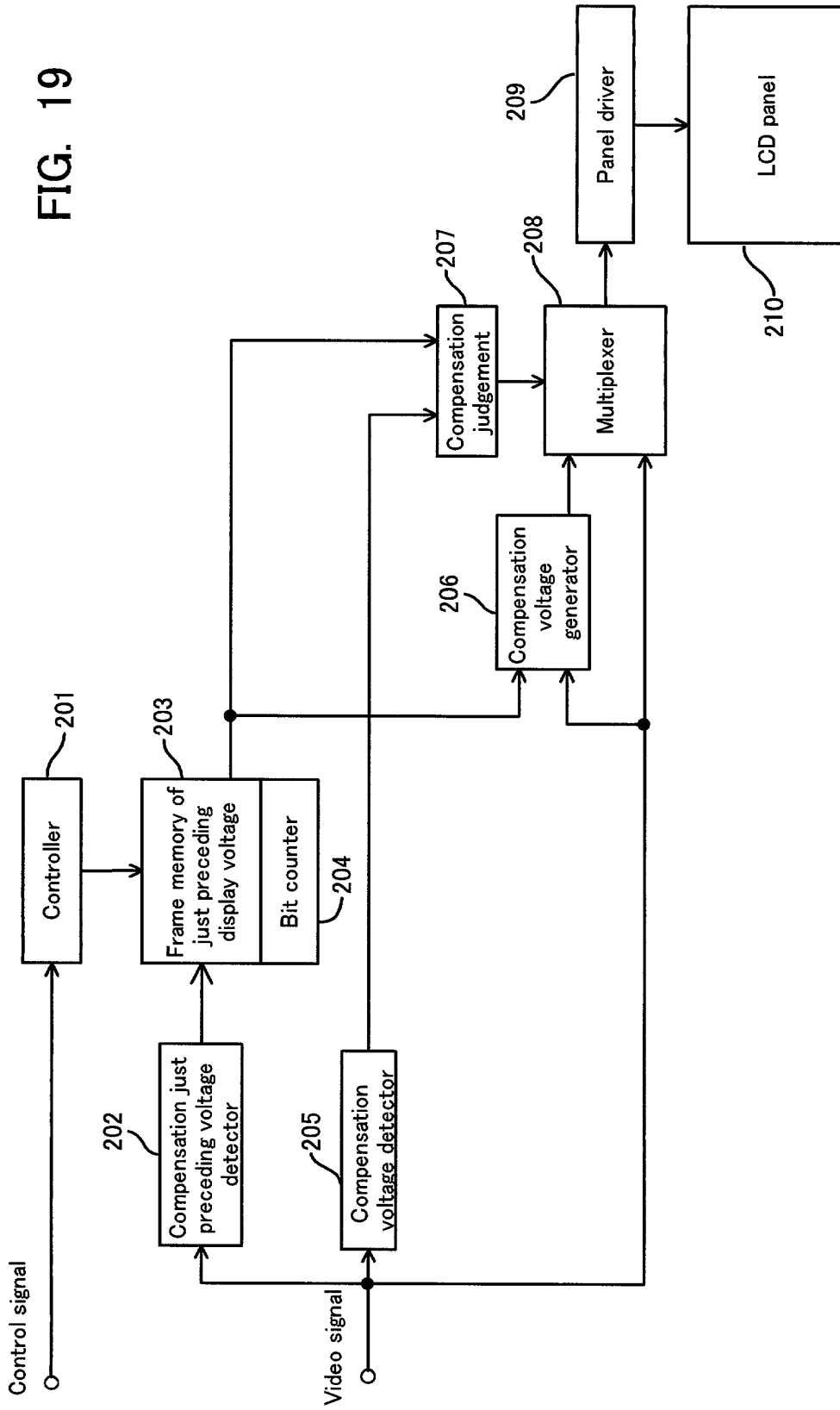

FIG. 20A No Compensation

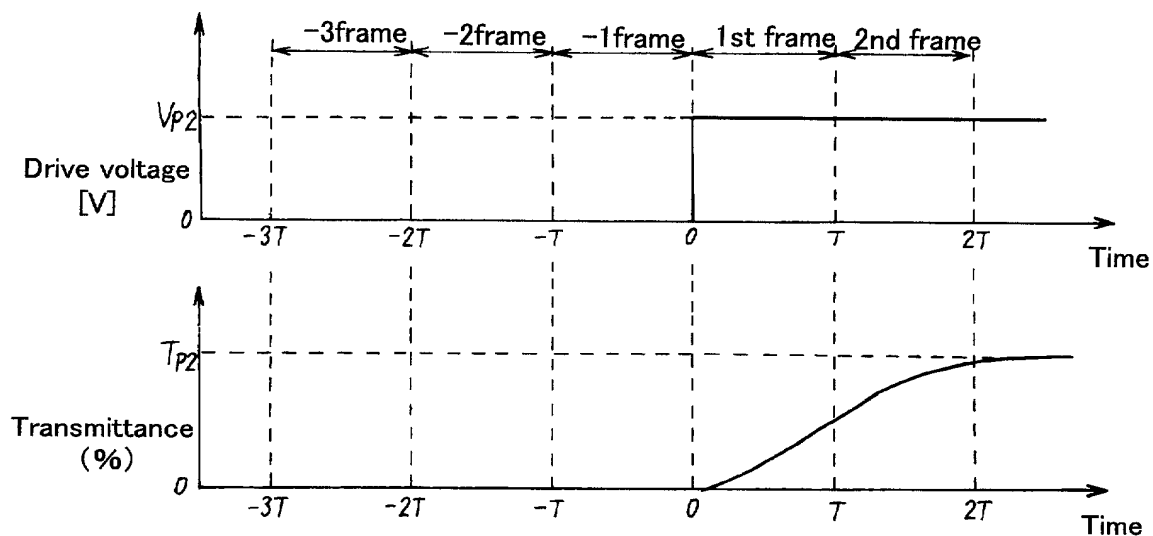

FIG. 20B

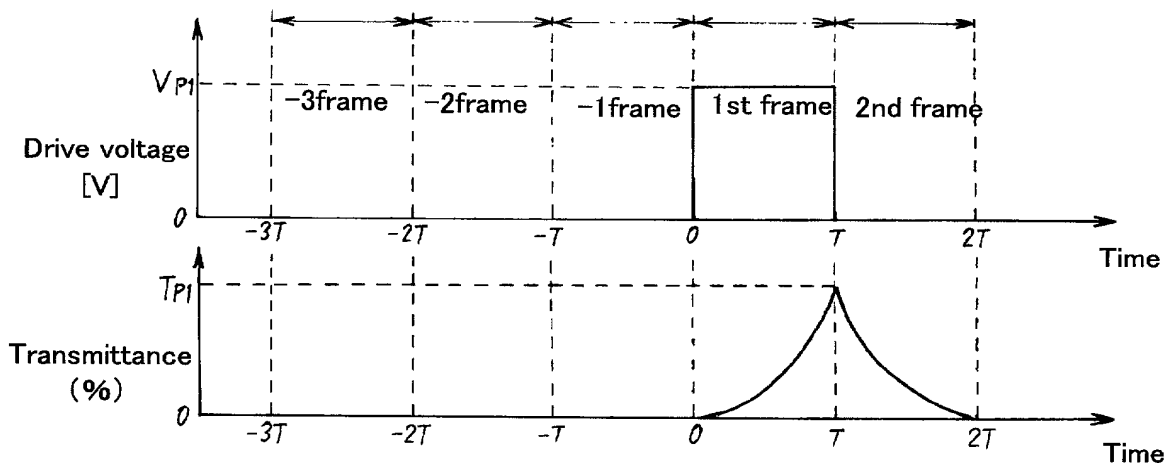

FIG. 20C With Compensation

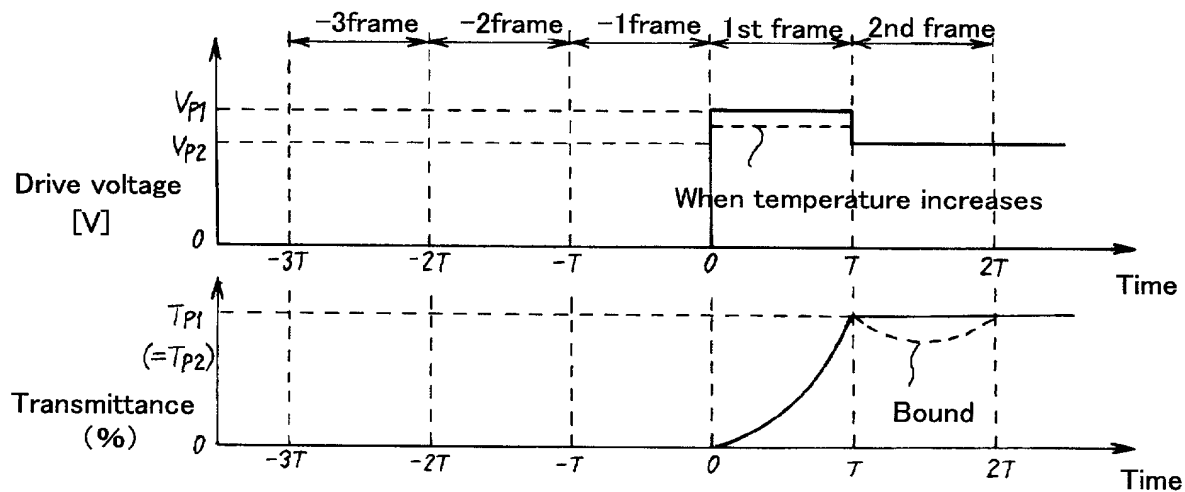

FIG. 21

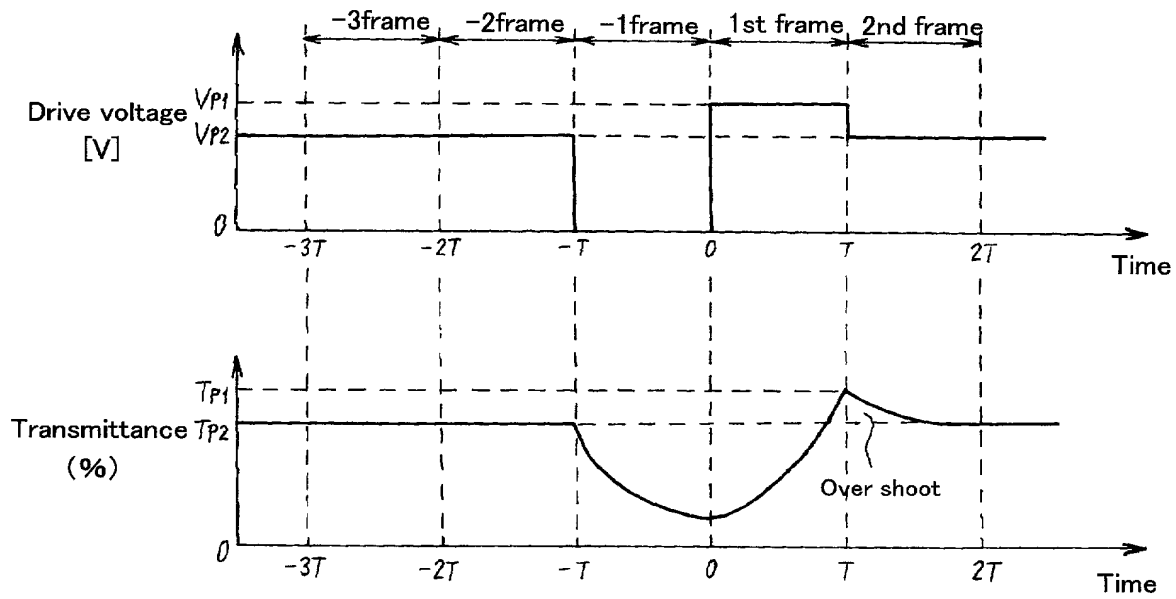

FIG. 22

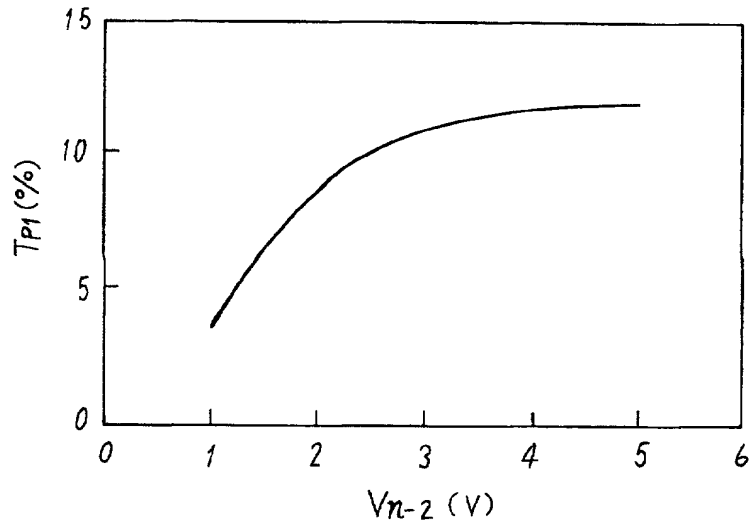
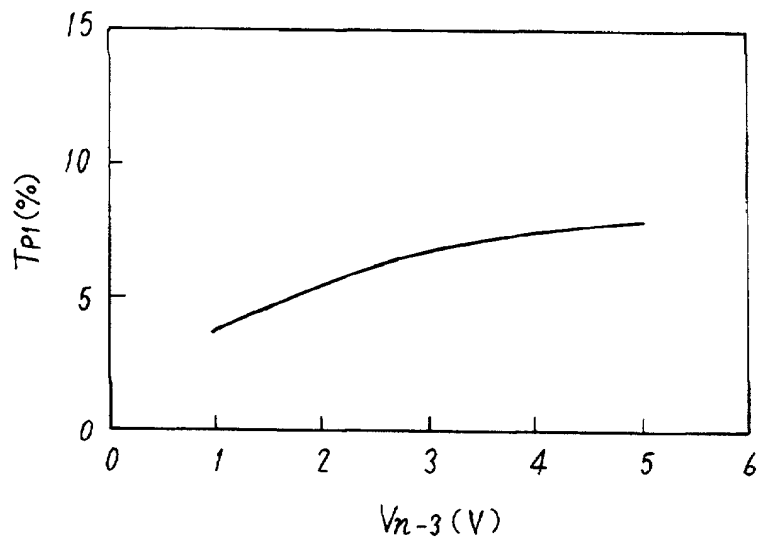

FIG. 23



Patented in the U.S.A. and other countries.

FIG. 24

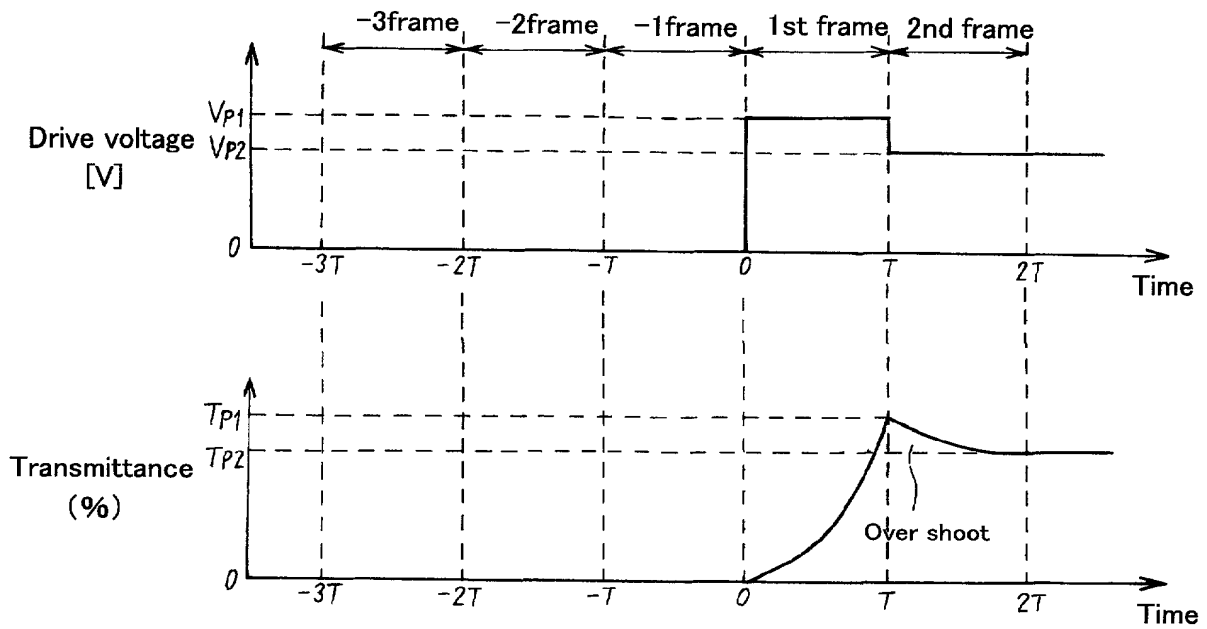

FIG. 25

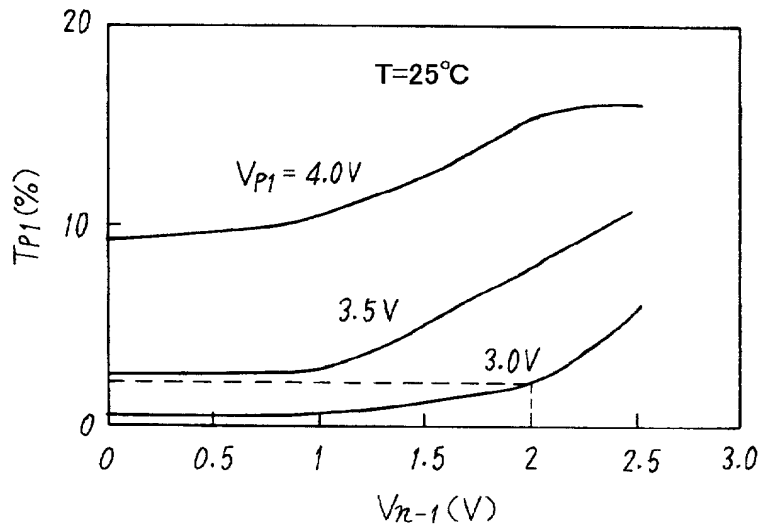

FIG. 26

